



# USER MANUAL

## FOR USING WEBLOGIC™

v1.25.0

*Original Instructions*

# Contents

<b>1. Introduction.....</b>	<b>5</b>
1.1. Important Safety Notice.....	5
1.2. Scope of the Manual.....	5
1.2.1. SG.....	5
1.2.2. Software and Firmware.....	5
1.2.2.1. Compute Box Software.....	5
1.3. Naming Convention.....	5
1.3.1. Compute Box/Eye Box.....	5
1.4. Copyright.....	5
<b>2. Safety.....</b>	<b>7</b>
2.1. Intended Use.....	7
2.2. General Safety Instructions.....	7
2.3. Risk Assessment.....	9
2.4. Environmental Safety.....	9
<b>3. HW Installation.....</b>	<b>11</b>
3.1. Overview.....	11
3.2. Robot Mount.....	11
3.2.1. Tools.....	11
3.2.1.1. SG.....	11
3.3. Compute Box Mount.....	11
3.3.1. Optional - Clip-on Bracket.....	11
3.4. Wiring.....	12
3.4.1. Tool Data Cable.....	12
3.4.2. Digital I/O Wires.....	13
3.4.3. Ethernet Cable.....	15
3.4.4. Compute Box DIP Switch Settings.....	15
3.4.5. Recommended Grounding.....	16
3.4.6. Power Supply: Compute Box.....	16
3.4.6.1. SG.....	17
<b>4. Operation.....</b>	<b>18</b>
4.1. Overview.....	18
4.2. Ethernet Interface Setup.....	18
4.3. Web Client.....	20
4.4. OnRobot WebLogic™ Menu.....	22
4.4.1. Browser.....	22
4.4.2. Program Editor.....	22
4.4.3. Program Editor: Conditions.....	24
4.4.4. Program Editor: Commands.....	25
4.4.5. Program Editor: List of Device Specific Values.....	27

4.4.5.1. SG.....	27
<b>5. Additional Software Options.....</b>	<b>29</b>
5.1. Compute Box/Eye Box.....	29
5.1.1. Web Client: Devices Menu.....	29
5.1.1.1. SG.....	30
5.1.2. Web Client: Configuration Menu.....	31
5.1.3. Web Client: Weblogic Menu.....	32
5.1.4. Web Client: Update Menu.....	32
5.1.5. Web Client: TCP/CoG.....	34
5.1.6. Web Client: Account Settings.....	35
<b>6. Hardware Specification.....</b>	<b>39</b>
6.1. Technical Sheets.....	39
6.1.1. Quick Changers.....	39
6.1.2. SG.....	40
6.1.3. Compute Box.....	42
6.1.3.1. With 1.5A Wall Adapter (36W).....	42
6.1.3.2. With 6.25A Wall Adapter (150W).....	42
6.1.3.3. Compute Box I/O interface.....	43
6.2. Mechanical Drawings.....	44
6.2.1. Mountings.....	44
6.2.1.1. Quick Changer - Robot Side.....	44
6.2.2. Tools.....	45
6.2.2.1. SG.....	45
6.2.2.2. Compute Box.....	46
6.3. TCP, CoG.....	46
6.3.1. SG.....	47
<b>7. Maintenance.....</b>	<b>49</b>
7.1. SG.....	49
<b>8. Troubleshooting.....</b>	<b>51</b>
8.1. SG Error Codes.....	51
8.1.1. Not Initialized.....	51
8.1.2. Unknown Silicone.....	51
<b>9. Warranties.....</b>	<b>52</b>
9.1. Patents.....	52
9.2. Product Warranty.....	52
9.3. Disclaimer.....	52
<b>10. Certifications.....</b>	<b>54</b>
10.1. Manufacturer Test Certificate.....	55
10.2. EMC.....	56

10.3. SG - Environment.....	57
10.4. SG-x-H.....	58
10.5. SG-x-S.....	60
10.6. Declaration of Incorporation.....	63
10.6.1. SG.....	63

# 1. Introduction

## 1.1. Important Safety Notice



**DANGER:**

You must read, understand, and follow all safety information in this manual, the robot manual, and all associated equipment before initiating robot motion. Failure to comply with safety information could result in serious injury or death.

## 1.2. Scope of the Manual

The manual covers the following OnRobot products and their components:

### 1.2.1. SG

Tool	Version
SG	v1

### 1.2.2. Software and Firmware

#### 1.2.2.1. Compute Box Software

The manual covers the following Compute Box software version:

Software	Version
Compute Box	v6.5.x



**NOTE:**

When the used Compute Box has lower software/firmware version, update the Compute Box. For detailed instructions, see [5.1.4. Web Client: Update Menu](#).

## 1.3. Naming Convention

### 1.3.1. Compute Box/Eye Box

Eye Box and Compute Box are used interchangeably.

## 1.4. Copyright

The information contained herein is property of OnRobot A/S and shall not be reproduced in whole or in part without prior written approval of OnRobot A/S. The information herein is

subject to change without notice and should not be construed as a commitment by OnRobot A/S. This manual is periodically reviewed and revised.

OnRobot A/S assumes no responsibility for any errors or omissions in this document.

Copyright © 2015–2025 by OnRobot A/S.

The OnRobot A/S logo is trademark of OnRobot A/S.

## 2. Safety

The robot integrator is responsible for ensuring that the applicable safety laws and regulations in the country concerned are observed and that any significant hazards in the complete robot application are eliminated. This includes, but is not limited to:

- Performing a risk assessment for the complete robot system
- Conduct a risk assessment and implement appropriate safety measures when interfacing with other machines
- Interfacing other machines and additional safety devices if defined by the risk assessment
- Setting up the appropriate safety settings in the robot software
- Ensuring that the user will not modify any safety measures
- Validating that the total robot system is designed and installed correctly
- Specifying instructions for use
- Marking the robot installation with relevant signs and contact information of the integrator
- Collecting all documentation in a technical file; including the risk assessment and this manual

### 2.1. Intended Use

---

OnRobot tools and accessories are intended to be used on collaborative robots and light industrial robots with different payloads depending on the end-of-arm tooling specifications. OnRobot tools and accessories are normally used in pick-and-place, palletizing, machine tending, assembly, quality testing and inspection and surface finishing applications.

The end-of-arm tooling and the accessories should only operate under conditions noted in [6.1. Technical Sheets](#) section.

Any use or application deviating from intended use is deemed to be impermissible misuse. This includes, but is not limited to:

- Use in potentially explosive atmospheres
- Use in medical and life critical applications
- Use before performing a risk assessment
- Use outside the permissible operational conditions and specifications
- Use close to a human's head, face and eye area
- Use as a climbing aid

### 2.2. General Safety Instructions

---

Generally, all national regulations, legislations and laws in the country of installation must be observed. Integration and use of the product must be done in compliance with precautions in this manual. Particular attention must be paid to the following warnings:

**DANGER:**

You must read, understand, and follow all safety information in this manual, and the robot manual and all associated equipment before initiating robot motion. Failure to comply with safety information could result in death or serious injury.

The information in this manual does not cover designing, installing, and operating a complete robot application, nor does it cover other peripheral equipment that can influence the safety of the complete system. The complete system must be designed and installed in accordance with the safety requirements set forth in the standards and regulations of the country where the robot is installed.

Any safety information provided in this manual must not be construed as a warranty, by OnRobot A/S, that the robot application will not cause injury or damage, even if robot application complies with all safety instructions.

OnRobot A/S disclaims any and all liability if any of OnRobot tools tooling are damaged, changed or modified in any way. OnRobot A/S cannot be held responsible for any damages caused to any of OnRobot tools tooling, the robot, or any other equipment due to programming errors or malfunctioning of any of OnRobot tools.

**WARNING:**

OnRobot tools are not allowed to be exposed to condensing conditions when power is on or when connected to a robot. If condensing conditions appear during transport or storage, the product must be placed between 20 and 40 Celsius degrees for 24 hours before power is applied or before connected to a robot.

It is recommended that OnRobot tools are integrated in compliance with the following guides and standards:

- ISO 10218-2
- ISO 12100
- ISO/TR 20218-1
- ISO/TS 15066

**WARNING:**

- The tools have to be properly secured before operating the robot.
- Keep fingers, clothes and hair away from the tool while the power is on.
- Always use protective glasses when working with sharp objects.
- Always ensure complete shutdown of the robot when working on the system for maintenance or inspection.
- Do not use the tools on people or animals.
- Do not perform any modification to the tooling.
- If the robot supports a bounded workspace/ speed/ force limit, make sure to use those features.
- Select robot trajectories that minimize risks of internal clamping between robot joints and tooling.

## 2.3. Risk Assessment

---

The robot integrator must perform a risk assessment on the complete robot application. OnRobot tools are partly completed machinery. The integrator must consider safety aspects of the completed machine so it can be operated in a safe way. OnRobot tools are designed with relatively smooth and round design with a limited amount of sharp edges and pinch points

In collaborative applications, the trajectory of the robot can play a significant safety role. The integrator must consider the angle of contact with a human body, e.g. orientate OnRobot tools and workpieces so that the contact surface in the direction of movement is as large as possible. It is recommended that the tool connectors are pointed in the direction opposite to the movement.

OnRobot A/S have identified the potential hazards listed below as significant hazards that must be considered by the integrator:

- Objects flying from OnRobot tools due to loss of grip
- Objects falling down from OnRobot tools due to loss of grip
- Injuries due to collisions between humans and workpieces, OnRobot tools tooling, robot or other obstacles
- Consequences due to loosened bolts
- Consequences if OnRobot tools cable gets stuck to something
- Hazards created by the workpiece itself

## 2.4. Environmental Safety

---

OnRobot A/S products must be disposed of in accordance with the applicable national laws, regulations, and standards.

The product is produced with restricted use of hazardous substances to protect the environment, as defined by the EU RoHS Directive 2011/65/EU, as amended by 2015/863/EU and 2017/2102/EU. These substances include mercury, cadmium, lead, chromium VI, polybrominated biphenyls, polybrominated diphenyl ethers, Bis(2-ethylhexyl) phthalate, Butyl benzyl phthalate, Dibutyl phthalate and Diisobutyl phthalate.

Observe national [registration](#) requirements for importers according to the EU WEEE Directive 2012/19/EU, which governs the disposal and recycling of electrical and electronic equipment.



**Declaration on substances of very high concern (SVHC) in accordance with regulation (EC) No 1907/2006 (REACH Regulation)**

In accordance with the duty to communicate information pursuant to Article 33 of the REACH Regulation we hereby declare the required information on SVHC's in OnRobot A/S products.

The European Chemicals Agency (ECHA) has published on its website a list of substances of very high concern (SVHC) which meet the criteria listed in Article 57 of the REACH Regulation and have been identified in accordance with Article 59 of the REACH Regulation ([Candidate List of substances of very high concern for Authorisation - ECHA \(europa.eu\)](#)).

We are required to inform customers of any products that contain SVHC's in a concentration above 0.1% w/w.

Our products are compliant with the requirements and restrictions of the REACH Regulations regarding the SVHC's.

## 3. HW Installation

### 3.1. Overview

For a successful installation the following steps will be required:

- Mount the components
- Setup the software

In the following sections, these installation steps will be described.

### 3.2. Robot Mount

1. Mount the robot-specific adapter (if applicable):
2. Mount any optional accessories
3. Mount the Quick Changer option
4. Mount the tool(s)

#### 3.2.1. Tools

##### 3.2.1.1. SG

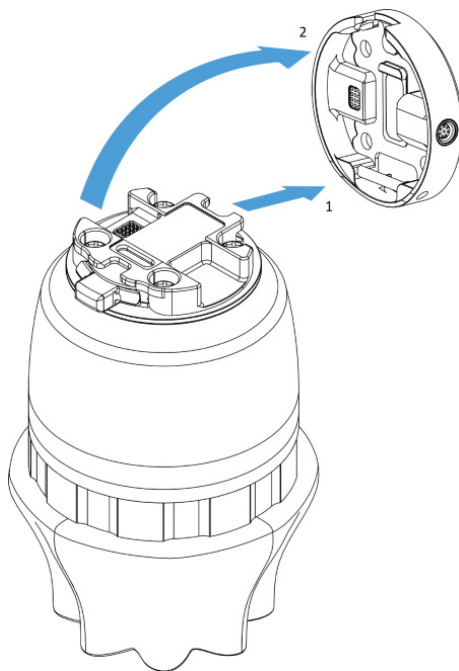

#### Step 1:

Move the tool close to the Quick Changer as illustrated.

The hook mechanism (rod and hook tongue) will keep the lower part locked once mounted.

#### Step 2:

Flip the tool until it is fully mated, and you hear a clicking sound.

To unmount the tool, press the aluminum button on the Quick Changer and repeat the steps in the reverse order.

### 3.3. Compute Box Mount

#### 3.3.1. Optional - Clip-on Bracket

Optionally, fix the Compute Box to a surface using the provided Clip-on Brackets ( included only from 17th December 2020).

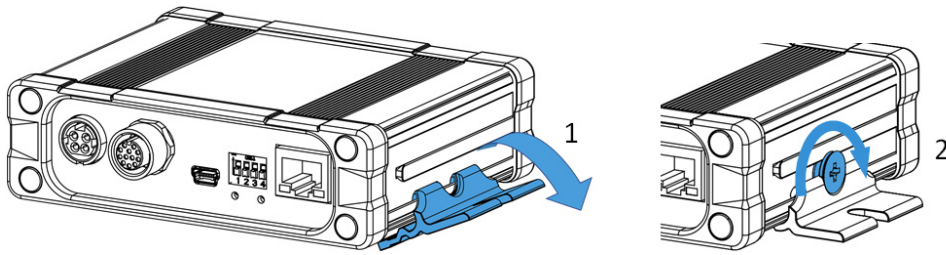

Do the following on both sides of the Compute Box:

1. Hook the Clip-on Bracket to the rail on the side of the Compute Box and then flip it down.
2. Fasten the Clip-on Bracket with the plastic screw.

### 3.4. Wiring

Four kind of cables must be connected to wire the system properly:

- Tool data cable between the tool(s) and the Compute Box
- The provided Digital I/O wires between the Computer Box and the robot controller
- Ethernet communication cable between the Compute Box and your computer
- Power supply of the Compute Box

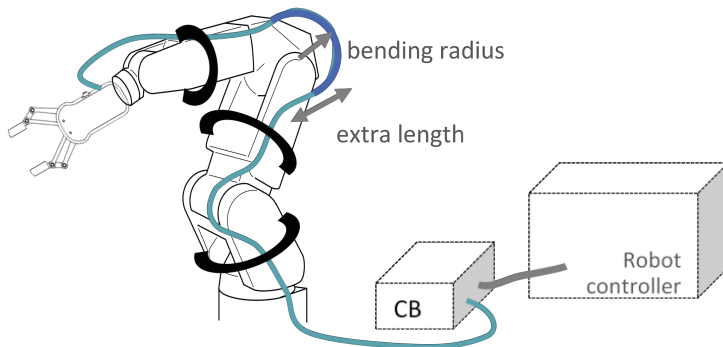

#### 3.4.1. Tool Data Cable

Connect the data cable to the tool(s) then route the cable (blue line) to the Compute Box (CB) and use the supplied Velcro tape (black) to fix it.



**NOTE:**

Leave some extra cable length around the joints so that the cable is not pulled when the robot moves.

Also make sure that the cable bending radius is minimum 40mm (for the HEX-E/H QC it is 70mm)

Then, connect the other end to the Compute Box's DEVICES connector.



**CAUTION:**

Use only original OnRobot tool data cables.

**3.4.2. Digital I/O Wires**

1. Connect the Compute Box to the robot controller.
2. Ensure the robot is powered off.
3. Check the controller power supply types and follow the robot manual to change it.
4. Verify the controller type (PNP or NPN) on the controller.

Based on the controller type, configure the Compute Box DIP switches (red) accordingly:

**PNP or NPN settings: DIP switch 1 for digital inputs and DIP switch 2 is for digital outputs.**

**PNP – Common GND system**

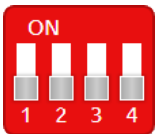

For **PNP** type set the 1. and 2. DIP switches to OFF position (down).

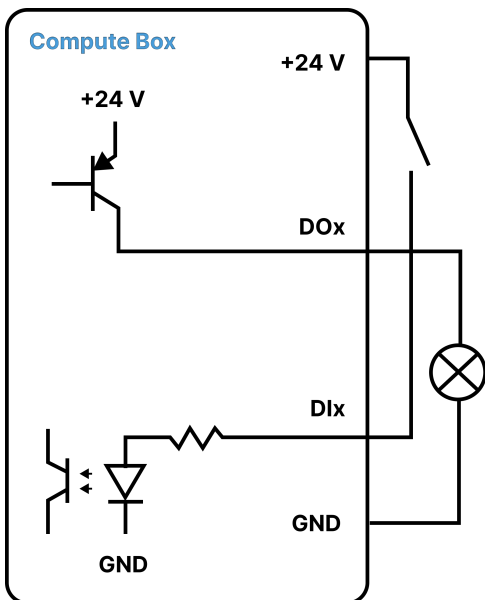

### NPN – Common +24 V system

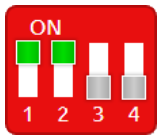

For **NPN** type set the 1. and 2. DIP switches to ON position (up).

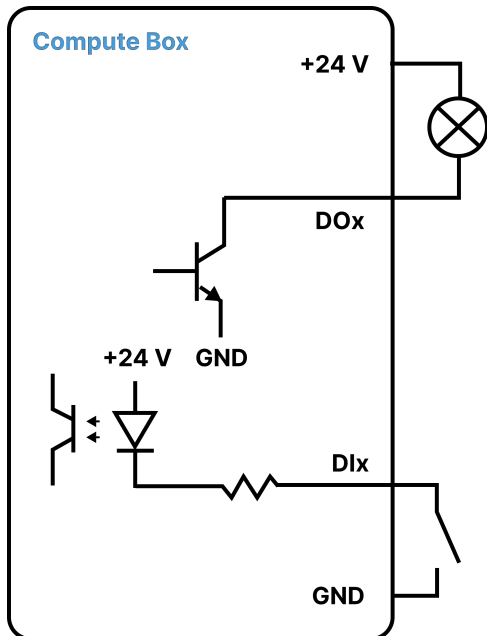

Plug in the supplied green pluggable connectors.

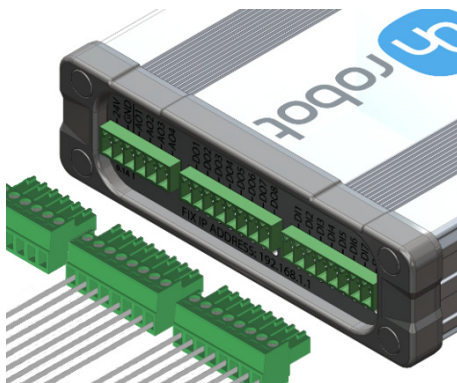

The supplied connector types are:

2 x Phoenix Contact MC 1,5/8-ST-3,5 Terminal Block

1 x Phoenix Contact MC 1,5/6-ST-3,5 Terminal Block

Wire the digital I/O wires from the Compute Box to the robot.

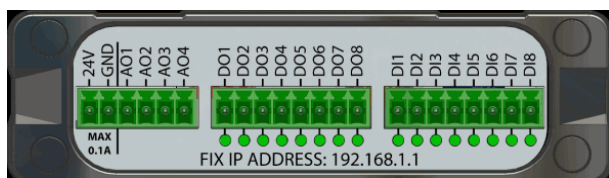

**DO1-8:** Digital outputs of the Compute Box (signals from the grippers/sensor to the robot)

**DI1-8:** Digital inputs of the Compute Box (signals from the robot to the grippers/sensor)

**GND:** To be used to have a common ground between the robot and the gripper/sensor

It is recommended to connect all 8 inputs and 8 outputs for simplicity.



**CAUTION:**

If some of the DO1-8 or DI1-8 wires will not be connected, make sure to unscrew it from the terminal block to avoid an accidental short circuit.



**CAUTION:**

The 24V and GND pins are only Reference Voltage Output. It cannot be used to power any equipment.

It is recommended to use the supplied wires only. If it is necessary to use different wire, use one that is shorter than 3 m.

Connect the Compute Box inputs to the robot outputs and the Compute Box outputs to robot inputs.

For simplicity, it is recommended to map the pins in order:

- |                                    |                                     |
|------------------------------------|-------------------------------------|
| DO1 to the robot's Digital input 1 | DI1 to the robot's Digital output 1 |
| DO2 to the robot's Digital input 2 | DI2 to the robot's Digital output 2 |
| ...                                | ...                                 |
| DO8 to the robot's Digital input 8 | DI8 to the robot's Digital output 8 |

After you connected the Compute Box to the robot controller through the provided Digital I/O wires, continue the wiring as described in [Ethernet Cable](#) section.

### 3.4.3. Ethernet Cable

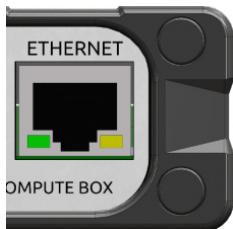

Connect the provided Compute Box (ETHERNET connector) and your computer with the supplied Ethernet Cat 5e cable.

It is recommended to use Ethernet cables that are shorter than 3 m.

This connection is only needed for programming.



**WARNING:**

Check and make sure that the Compute Box enclosure (metal) and the robot controller enclosure (metal) are not connected (no galvanic connection between the two).

### 3.4.4. Compute Box DIP Switch Settings

Set the DIP switches of the Compute Box as follows:

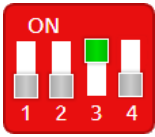

Set the DIP switch 3 to ON and the DIP switch 4 to OFF position.

For more information about the Ethernet interface settings, see [4.2. Ethernet Interface Setup](#).

### 3.4.5. Recommended Grounding



#### WARNING:

Incorrect grounding can result in device damage. Please follow the recommendations below.



1. Connect all metal devices\* to a central point. Use 4mm ground wires.
2. Connect the central point to the factory ground. Use a 6mm ground wire.
3. Check grounding by moving a Grounding Tester\*\* throughout the setup. Confirm the device reads close to 0.

To learn more about grounding checking, watch the tutorial on <https://learn.onrobot.com/en/how-test-grounding>.

\* We refer to metal devices as OnRobot devices, robot, fences, conveyor belts, machines, etc, that are in the application.

\*\* Can be purchased at OnRobot with the Item Number #114040.

### 3.4.6. Power Supply: Compute Box

Connect the supplied power supply to the Compute Box 24V connector.

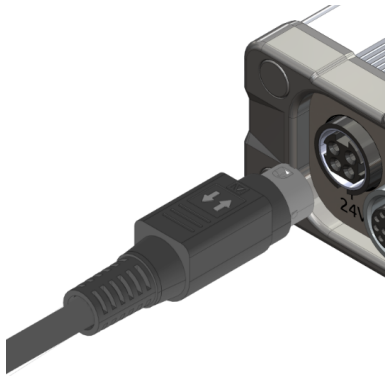

**NOTE:**

To disconnect the power connector, make sure to pull the connector housing (where the arrows are shown) and not the cable.



**CAUTION:**

Use only original OnRobot power supplies.

Finally, power up the power supply that will power the Compute Box and the connected Tool(s).

**3.4.6.1. SG**

Power Supply	
1.5 A	✓
5 A	✓
6.25 A	✓

## 4. Operation



### NOTE:

It is assumed that the Installation has finished successfully. If not, first do the installation steps in the previous section.

### 4.1. Overview

OnRobot WebLogic™ requires to be programmed first with the help of a computer connected to the Compute box. Then it can run standalone without any Ethernet connection.

Steps to program it:

- Setup the Compute Box's Ethernet interface and connect to the Compute Box
- Open the Web Client on your computer to access the WebLogic™ menu
- Write your program in the WebLogic™ menu

The following subsections will guide you through these steps.

### 4.2. Ethernet Interface Setup

A proper IP address must be set for the Compute Box/Eye Box and the robot/computer to be able to use the Ethernet interface. The IP address can be configured using DIP switches 3 and 4.



### WARNING:

Stop the robot program before you change any Ethernet interface settings.



### NOTE:

Configuring DIP switch 3 will remove any previously set static IP address.

To change between modes, first change the DIP switches and then cycle the Compute Box/Eye Box power so the changes will take effect.

**DIP 3** - sets the Compute Box / Eye Box IP address

- **ON:** Fixed IP (192.168.1.1)
- **OFF:** Dynamic or Static IP (*can be configured via the Web Client*)

**DIP 4** - sets whether the connected robot or laptop will receive IP address from the Compute Box / Eye Box

- **ON:** DHCP server is disabled
- **OFF:** DHCP server is enabled

We recommend to set the DIP switches according to either of the two options below:

- **Fix IP/Auto mode** - in simple installations (no external network and/or no PLC connected)
- **Advanced mode** - in more complex installations (external network and/or PLC are used)

### Fix IP/Auto mode (factory default)

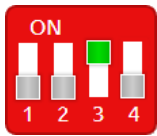

Set the DIP switch 3 to ON and the DIP switch 4 to OFF position and cycle the power so the changes will take effect.

IP Address of the Compute Box/Eye Box	IP Address of the Robot/Computer
<p>The IP address of the Compute Box/Eye Box is fixed 192.168.1.1. This IP address cannot be changed.</p>	<p>The Compute Box/Eye Box will automatically assign an IP address to the connected robot/computer if it was configured to obtain an IP address automatically.</p> <div data-bbox="719 741 815 831" style="display: inline-block; vertical-align: middle; margin-right: 10px;"> </div> <p><b>NOTE:</b> The assigned IP address range is 192.168.1.100-105 (with subnet mask 255.255.255.0). If the Compute Box/Eye Box is used in a company network where a DHCP server is already in use, it is recommended to use Advanced mode.</p>

In this mode, the DHCP server of the Compute Box/Eye Box is enabled.

### Advanced mode (any static or dynamic IP/subnet mask)

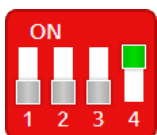

Set the DIP switch 3 to OFF and the DIP switch 4 to ON position and cycle the power so the changes will take effect.

IP Address of the Compute Box/Eye box	IP Address of the Robot/Computer
<p><b>Case 1:</b> Static IP address The IP address 192.168.1.1 is already in use in your network or a different subnet needs to be configured.</p>	<p>The Compute Box/Eye Box will not assign an IP address to the robot/computer. Set the IP address of the robot/computer manually. Make sure to have a matching IP setting to your robot/computer network for a proper communication. Use the same subnet but different IP address.</p>
<p><b>Case 2:</b> Dynamic IP address *</p>	<p>The IP address of the robot/computer is set dynamically. An external DHCP server assigns the IP address to the robot/computer.</p>

\* By default, the IP address of the Compute Box/Eye Box is set to Dynamic IP.

The IP address of the Compute Box/Eye Box can be set to any value by using the Web Client. For more details, see section [Web Client: Configuration Menu](#). Under **Network settings**, set the **Network mode** to either **Static IP** or **Dynamic IP**.

In this mode, the DHCP server of the Compute Box/Eye Box is disabled.

### 4.3. Web Client

---

To access the Web Client on your computer first the Ethernet interface needs to be set up to have a proper communication between your computer and the Compute Box. It is recommended to use the factory default DIP switch settings (DIP 3 On and DIP 4 Off) (for further details see section [4.2. Ethernet Interface Setup](#)).

Then do the following steps:

- Connect the Compute Box to your computer with the supplied UTP cable.
- Power the Compute Box with the supplied power supply
- Wait one minute for the Compute Box LED to turn from blue to green.
- Open a web browser on your computer and type in the IP address of the Compute Box (factory default is 192.168.1.1).

The Sign-in page opens:

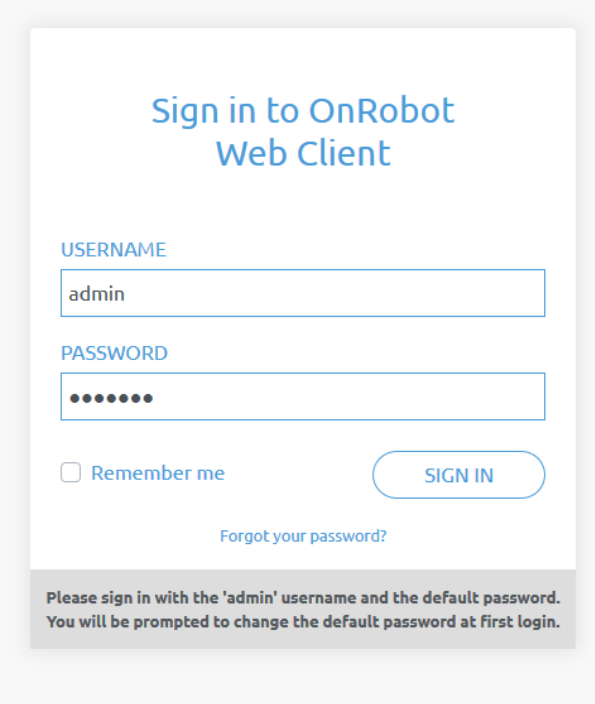

Sign in to OnRobot  
Web Client

USERNAME  
admin

PASSWORD  
●●●●●●

Remember me

[Forgot your password?](#)

Please sign in with the 'admin' username and the default password.  
You will be prompted to change the default password at first login.

The factory default administrator login is:

**Username:** admin

**Password:** OnRobot

For the first login a new password needs to be entered: (password must be at least 8 characters long)

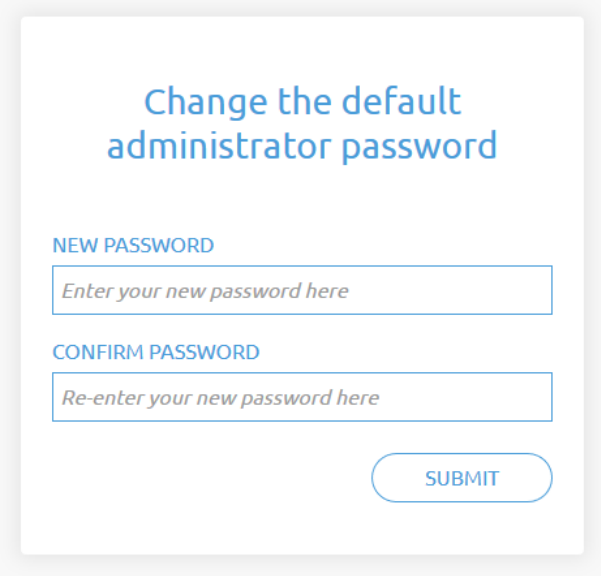

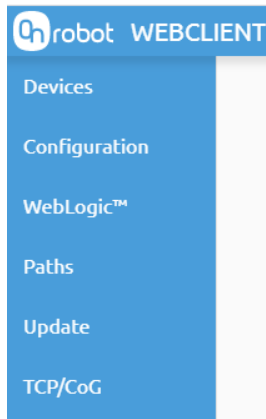

Once signed in the following menu will appear on the left side of the screen:



- **Devices** - Monitor and control the connected devices (e.g.: grippers)
- **Configuration** - Change the Compute Box's settings
- **WebLogic™** - Program the Digital I/O interface through OnRobot WebLogic™
- **Paths** - Import/export the recorded Paths (not available to all robots)
- **Update** - Update the Compute Box and the devices
- **TCP/CoG** - Calculate the TCP (Tool Center Point) and CoG (Center of Gravity) values for your OnRobot product combination.

The following menu will appear in the top right corner of the screen:



-  Select the language of the Web Client
-  Account settings (e.g.: change password, add new user)

In the following, these menu will be described.

## 4.4. OnRobot WebLogic™ Menu



There are two tabs to choose from:

- **Browser** - manage (import/export, etc.) the WebLogic™ programs
- **Program Editor** - create/edit or run WebLogic™ programs

In the following these two will be described.

### 4.4.1. Browser

This tab lists the WebLogic™ programs that are stored on the Compute Box.

- To create a new program, go to the **Program Editor** tab.
- To edit a stored program, click on the pencil  icon and it will be loaded in the **Program Editor**
- Any program can be deleted by clicking on the trash  icon.
- Programs can be exported to your computer by clicking on the down arrow  icon.
- Exported programs can be imported with the **Import** button.



#### NOTE:









The program name that are edited in the **Program Editor** is bolded.

OnRobot WebLogic

This page allows to browse/manage the OnRobot WebLogic programs. You can create new program and run it on the Editor tab. (To make your program run automatically on power-on, leave it running while powering the Compute Box off.)

Browser   Program Editor

IMPORT You can import a program file from your computer.

PROGRAM NAME	ROWS	SIZE	
Program 1	2	2,742	  
<b>Program 2</b>	<b>3</b>	<b>3,609</b>	  
Program 3	13	20,480	  

### 4.4.2. Program Editor

This tab shows the currently edited WebLogic™ program.

WebLogic™ programs contain 1 or more “rows”.

A row contains conditions (blue part) and commands (gray part) like this:

**(If)** DI1=1 **(Then)** (RG2-Width=77, force=20N)

(If the robot sets the Digital Input 1 (D1) of the Compute Box to high, **then** open the RG2 gripper to 77 mm.)

Another row in a program can be like this:  
**(If) DI1=0 (Then) (RG2-Width=20, force=40N)**

(If the robot sets the Digital Input 1 (D1) of the Compute Box to low, **then** close the RG2 gripper to 20 mm.)

With the above two rows in a program an RG2/6 gripper could be operated (opened and closed) with a single Digital output of a robot, while the opening and closing width and force can be programmed to any value.

To execute a WebLogic™ program first make sure to enter a program name and click on the **Save** button to store it and then click on the **Run** button.



**NOTE:**

To make a program run automatically when the Compute Box is powered on just leave the program running while you power the Compute Box off.

To start a new program, click on the **New** button.

- To add a new row, click on the **Add new conditions and commands**.
- To delete a row, click on the icon.
- To move the row up or down click on the icons.



**NOTE:**

Conditions and commands are executed from the top to the bottom. Same commands at the bottom can override the ones at the top.

- To duplicate a row, click on the icon.
  - To disable a row (not to be executed), uncheck the checkbox next to the row number.
- The rows must have at least one condition and at least one command to be executed.

### 4.4.3. Program Editor: Conditions

Conditions are the input fields marked by blue.

#### Condition Types

Digital Input type	Device specific value type
For example: DI4=1 	For example: HEX Fx > 10N 

#### Complex Conditions

To create more complex conditions, combine them using AND or OR logical operations. The logical operations can be changed independently by clicking on the AND or OR buttons.

Example:

**If ( DI4=1 ) OR ( HEX Fx > 10 N AND HEX Fx < 20N )**



This condition is true if the Fx is between 10N and 20N or the robot has signaled high in Digital Input 4.

#### Digital Input States

Digital inputs (DI1-DI8) can have the following three states: (click to cycle through the states)

- - Don't care (this bit is masked and will give true result for the bit)
- - give logic true if Input bit is low
- - give logic true if Input bit is high



**NOTE:**

If no Digital Input type of condition is needed set DI1-DI8 to  don't care.

**Device Specific Values**

For Device specific values first set the Select device by clicking on the arrow icon.

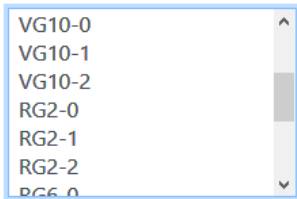

**NOTE:**

The list contains only the connected devices. If you would like to select a device that is not currently connected check the **Show all devices** checkbox.

For 2FG7, 3FG15, RG2/6, MG10, Screwdriver, SG, VG10, VGC10, and VGP20 there are three numbers after the device name:

- **0** - If the device is mounted on a Quick Changer or a HEX-E/H QC
- **1** - If the device is mounted on the Primary side of a Dual Quick Changer
- **2** - If the device is mounted on the Secondary side of a Dual Quick Changer





**NOTE:**

If a Device specific value type condition is not needed set it to -- **Not selected** -- and it will give true result.

**4.4.4. Program Editor: Commands**

Commands are the input fields marked with gray.

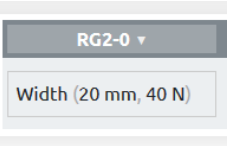
**Command Types**

Device specific value type	Digital Output type
<p>For example:</p>  <p>Sets RG2 width to 77 mm and with force = 20N.</p>	<p>For example: DO4=1</p>  <p>Sets Digital Output 4 to logic high.</p>



**NOTE:**

Both types are always executed so make sure that the not relevant part is always set to Don't change or -- **Not selected** --.

**Device Specific Values**

For Device specific value first set the Select device by clicking on the arrow icon.

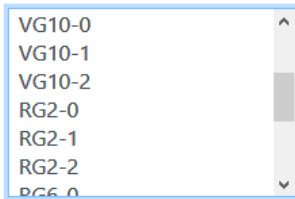

**NOTE:**

The list contains only the connected devices. If you would like to select a device that is not currently connected check the **Show all devices** checkbox.

For 2FG7, 3FG15, RG2/6, MG10, Screwdriver, SG, VG10, VGC10, and VGP20 there are three numbers after the device name:

- **0** - If the device is mounted on a Quick Changer or a HEX-E/H QC
- **1** - If the device is mounted on the Primary side of a Dual Quick Changer
- **2** - If the device is mounted on the Secondary side of a Dual Quick Changer

**Digital Output States**

Digital outputs (DO1-DO8) can have the following three states: (click to cycle through the states)

- - Don't change
- - set the Output bit to logic low
- - set the Output bit to logic high



**NOTE:**

OnRobot functions only accept input and returns output in metric units. If you have values to provide in US Standard units, use the following conversion rates.

US Standard unit	Metric unit	Convert US Standard unit into metric parameter input	Convert metric function output to US Standard unit
Linear measure (Length/Distance)			

US Standard unit	Metric unit	Convert US Standard unit into metric parameter input	Convert metric function output to US Standard unit
1 inch (in or ")	25.4 millimetres	Multiply the US Standard input by 25.4 to get the metric unit input.	Divide the metric output by 25.4 to get the US Standard unit output.
1 foot (ft or')	0.304 metre	Multiply the US Standard input by 0.304 to get the metric unit input.	Divide the metric output by 0.304 to get the US Standard unit output.
Mass (Weight)			
1 pound (lb)	0.453 kilogram	Multiply the US Standard input by 0.453 to get the metric unit input.	Divide the metric output by 0.453 to get the US Standard unit output.
Torque			
1 lbft	1.355 Nm	Multiply the US Standard input by 1.355 to get the metric unit input.	Divide the metric output by 1.355 to get the US Standard unit output.

#### 4.4.5. Program Editor: List of Device Specific Values

Each device has an **OnStart** condition that becomes True only once the device is connected or the program is started. It becomes False when the device is disconnected. This can be used to detect if a device is connected or set any initial value on program start.

An aggregated **Status** condition is available for all connected devices. The status is displayed as the condition of the General status device.

The status can be one of the following:

- Status == OK  
In this case all devices work properly.
- Status == Warning  
In this case minor issues occur for any of the devices.
- Status == Error  
In this case major issues occur for any of the devices.

##### 4.4.5.1. SG

Conditions	Description
<b>Width</b>	Actual gripper width [mm]
<b>Initialized</b>	Becomes <b>TRUE</b> when the gripper received a valid <b>Initialize</b> command otherwise <b>FALSE</b> .
<b>Busy</b>	Becomes <b>TRUE</b> when the gripper is moving otherwise <b>FALSE</b> .

Commands	Description
<b>Initialize</b>	The gripper first needs to be initialized by setting what type of SG Tool is used.
<b>Grip</b>	Set the small enough target width to grip on a part. If the <b>Gentle grip</b> option is <b>TRUE</b> than the speed of the grasp will be decreased 10mm before the set target width.
<b>Release</b>	Set the large enough target width to release the part.



## 5. Additional Software Options

### 5.1. Compute Box/Eye Box

#### 5.1.1. Web Client: Devices Menu

To control/monitor a device click on the **Select** button.

Please select from the detected device(s):

 <p>Compute Box</p> <p>SELECT</p>	 <p>HEX-E/H QC</p> <p>SELECT</p>	 <p>RG2</p> <p>SELECT</p>
--	---	--

### 5.1.1.1. SG

#### Soft Gripper

This page allows the device to be monitored and controlled. By navigating to the Device info tab the device status is shown. (Some functions might not be accessible without Admin permission.)

Monitor and control
Device info

##### States

Busy  
 Initialized

---

##### Select tool type

Current tool: None

None

  
SG-a-H

  
SG-a-S

  
SG-b-H

---

##### Set grip mode and width

GENTLE GRIP

TARGET WIDTH

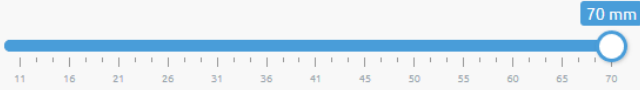

Current width: 90 mm

The **States** of the gripper could be:

- **Busy** - the gripper is moving
- **Initialized** - the gripper has been initialized.

#### Select tool type

- **Current tool** - Shows the currently selected SG tool. Select the desired SG tool, by clicking the adjacent radio button.
- Click on **Initialize** to initialize the selected SG tool

#### Set grip mode and width

The default gripping speed is set as **Gentle grip**, the gripping speed is reduced at 12.5mm before the specified target width, this results in a gentler grip, compared to normal grip settings.

The gripper can be controlled by adjusting the **Target width** slider, this will immediately control the gripper.

- **Current width** - shows the current width of the gripper.
- **Stop** button - stops the ongoing procedure.
- **Home** button - moves the gripper to its home position.

### 5.1.2. Web Client: Configuration Menu

Configuration

This page allows the configuration of the Compute Box / Eye Box.

**CAUTION**  
Incorrect settings may cause the device to lose network connectivity.

1. Digital input mode: NPN
2. Digital output mode: NPN
3. Compute Box / Eye Box IP setting is configured on this page.
4. DHCP server enabled: Compute Box / Eye Box tries to assign IP to the robot.

**NETWORK SETTINGS**

MAC address	B8:27:EB:0E:C9:A3
Network mode	Default Static IP
IP address	192.168.1.1
Subnet mask	255.255.255.0
Gateway	192.168.1.1

[SAVE](#)

**ETHERNET/IP SCANNER SETTINGS**

IP address to connect to	_____
Origin-to-target instance id	1
Target-to-origin instance id	1
Configuration instance id	0
Requested packet interval (ms)	8

[SAVE](#)

**COMPUTE BOX / EYE BOX SETTINGS**

Display name \_\_\_\_\_ [✎](#)

[SAVE](#)

Clock delay 0 sec ✔

[SYNCHRONIZE CLOCK](#)

**ROBOT SETTINGS**

Robot type	None
Robot ID	_____
Robot IP address	_____

[SAVE](#)

**WEBLYTICS SETTINGS**

WebLytics support	Disabled, discoverable
WebLytics IP address	_____
Connected to server	Disconnected

[SAVE](#)

**Network settings:**

The **MAC address** is a world-wide unique identifier that is fixed for the device.

The **Network mode** drop-down menu can be used to decide if the Compute Box will have a static or a dynamic IP address:

- If it is set to **Dynamic IP**, the Compute Box expects an IP address from a DHCP server. If the network that the device is connected to has no DHCP server, the Compute Box will not obtain an IP address and its LED is lighting in blue.
- If it is set to **Static IP**, then a fixed IP address and subnet mask must be set.
- If it is set to **Default Static IP**, the fixed IP revert to the factory default and cannot be changed.

After all parameters are set, click on the **Save** button to store the new values permanently. Wait 1 minute and reconnect to the device using the new settings.

#### Compute Box / Eye Box settings:

In case, more than one Compute Box is used within the same network, for identification purpose any user specific name can be entered to the **Display name**.

If the **Clock delay** field shows a difference, click **Synchronize clock** to synchronize the Compute Box's time with your computer.

#### EtherNet/IP scanner settings:



#### NOTE:

This is a special option of the EtherNet/IP connection for some robots.

In case when the robot is the Adapter and the Compute Box needs to be the Scanner the following addition information is required for the communication:

- **IP address to connect to** - the robot IP address
- **Origin-to-target instance id** - refer to the robot's EtherNet/IP manual (Scanner mode)
- **Target-to-origin instance id** - refer to the robot's EtherNet/IP manual (Scanner mode)
- **Configuration instance id** - refer to the robot's EtherNet/IP manual (Scanner mode)
- **Requested packet interval (ms)** - RPI value in ms (minimum 4)

Check the checkbox and the Compute Box will try to automatically connect to the robot (via the given IP address).

For information on the **Robot settings** and the **WebLytics settings**, see the WebLytics Manual.

### 5.1.3. Web Client: Weblogic Menu

For information about the WebLogic™ menu, see [4.4. OnRobot WebLogic™ Menu](#).

### 5.1.4. Web Client: Update Menu

This page can be used to update the software on the Compute Box and the firmware on the devices.

### Update

This page allows updating the software and firmware.

**CAUTION**  
Installing updates may take several minutes to complete. Please do not power off or unplug your Compute Box or any of the connected devices during the update process.

**SOFTWARE**

BROWSE

[Click here to download the result of the last update.](#)

**FIRMWARE**

COMPONENTS	CURRENT VERSION	REQUIRED VERSION	
<b>Compute Box (CBOX_RPT)</b>			
Firmware	150	150	✓
<b>HEX-E/H QC (HEXHC001)</b>			
Firmware	208	208	✓

UPDATE

✓ Up-to-date   
 ↻ Update required   
 ✗ Downgrade not supported



**CAUTION:**

During the update process (takes about 5-10 minutes) DO NOT unplug any device or close the browser window. Otherwise the updated device could be damaged.

The loading screens during the update process are the same for the software and the firmware updates.

**Software Update**

Download the latest .cbu file from the **Downloads** menu on the website.

Click on **Browse** to search for the .cbu software update file. The **Browse** button will turn to **Update**.

Click on **Update** to start the software update process.

If the update is finished and was successful, the message below is shown.

## Firmware Update

Update required: A firmware update is required because one of the components is out of date.

Click on **Update** in the firmware section of the page to start the firmware update process.

If the update is finished and was successful, the message below is shown.

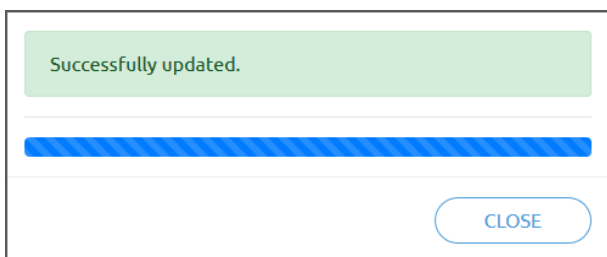
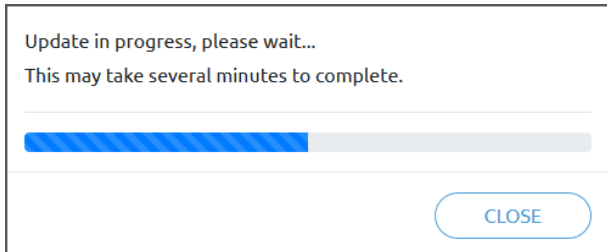

### 5.1.5. Web Client: TCP/CoG

Use the TCP/CoG calculator to calculate the TCP (Tool Center Point) and CoG (Center of Gravity) values for your OnRobot product combination.

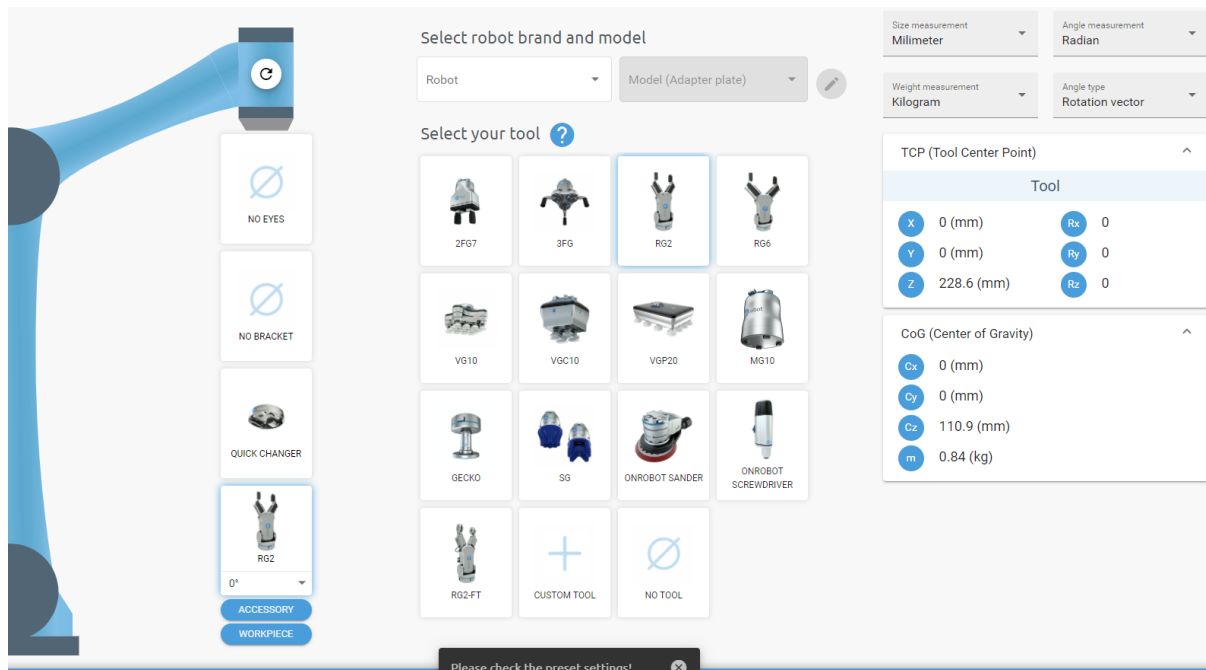

The TCP/CoG calculator will show the automatically detected settings.



**NOTE:**

Make sure to check the preset settings before calculating the TCP and CoG values.

1. Select the robot brand and the model you are using from the **Robot** and **Model (Adapter plate)** dropdown menus.



Click on  to set custom Adapter plate settings.

2. Click on the **No eyes** card to modify the Eyes preset settings.
3. Click on the **No bracket** card to modify the Angle Bracket preset settings.
4. Select mounting type.
5. Select tool.



Click on  to get help about how to enter the values.

6. Click on **Accessory** to select any OnRobot accessories.
7. Click on **Workpiece** to enter the workpiece weight. Then the calculator calculates the resulting payload mass considering the gripper, the mounting, and the workpiece mass.
8. Choose the unit of measure for the values you want to enter from the **Size measurement**, **Angle measurement**, **Weight measurement** and **Angle type** dropdown menus.

The calculator calculates the values which you can see in the **TCP (Tool Center Point)** and **CoG (Center of Gravity)** boxes. These values can be entered into the robot.

### 5.1.6. Web Client: Account Settings

This menu can be used to:

- See the currently sign-id user
- Go to **Account settings**
- Sign-out

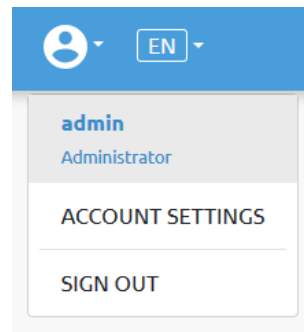

**Account settings:**

This page has two tabs:

- **My profile** - to see and update the currently logged in users' profile (e.g.: change password)
- **Users** - to manage users (e.g.: add/remove/edit)

On the **My profile** tab to change any profile data (e.g.: password) click on the **Update profile** button.

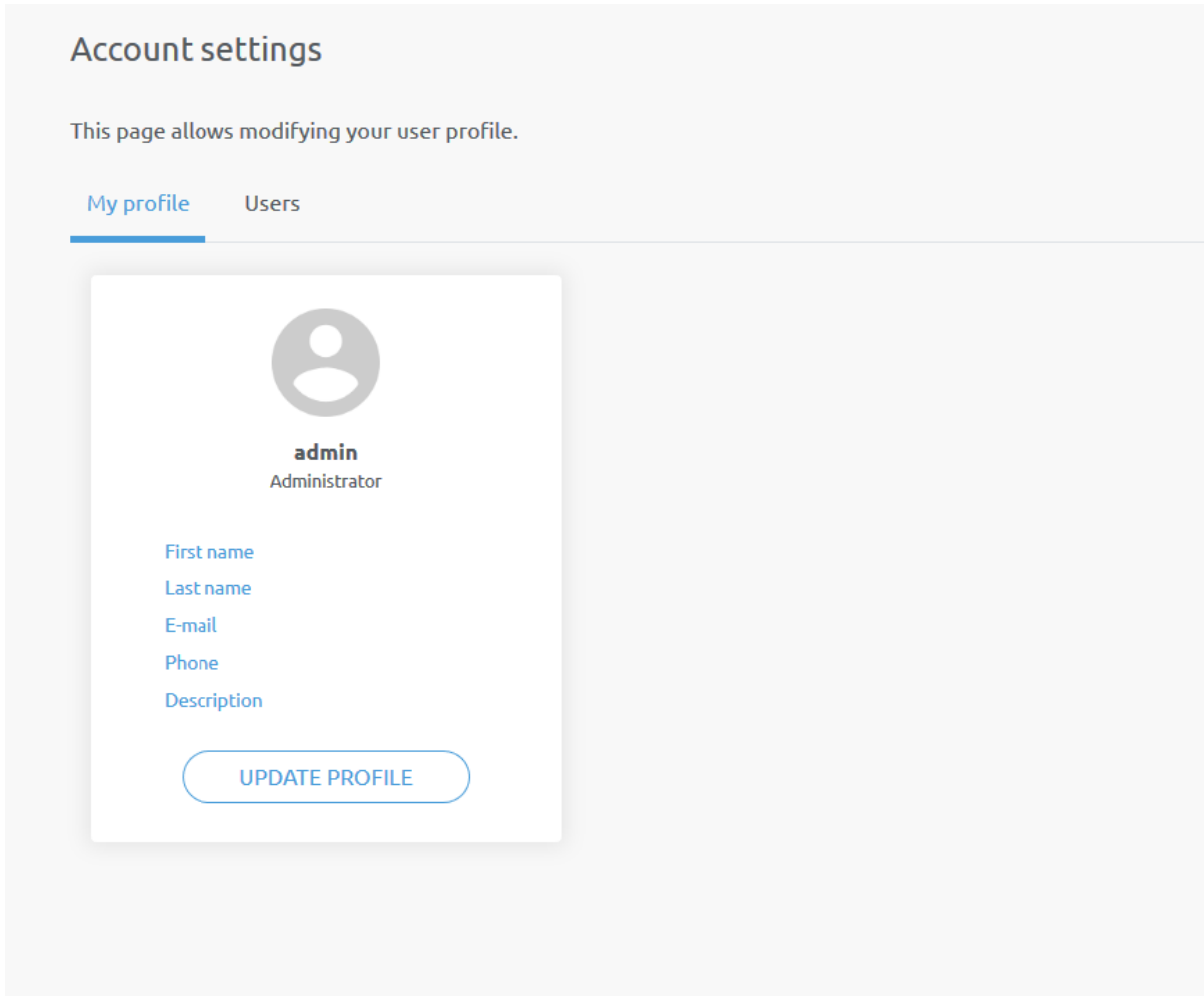

On the **Users** tab click on the **Add new user** button to add more users:

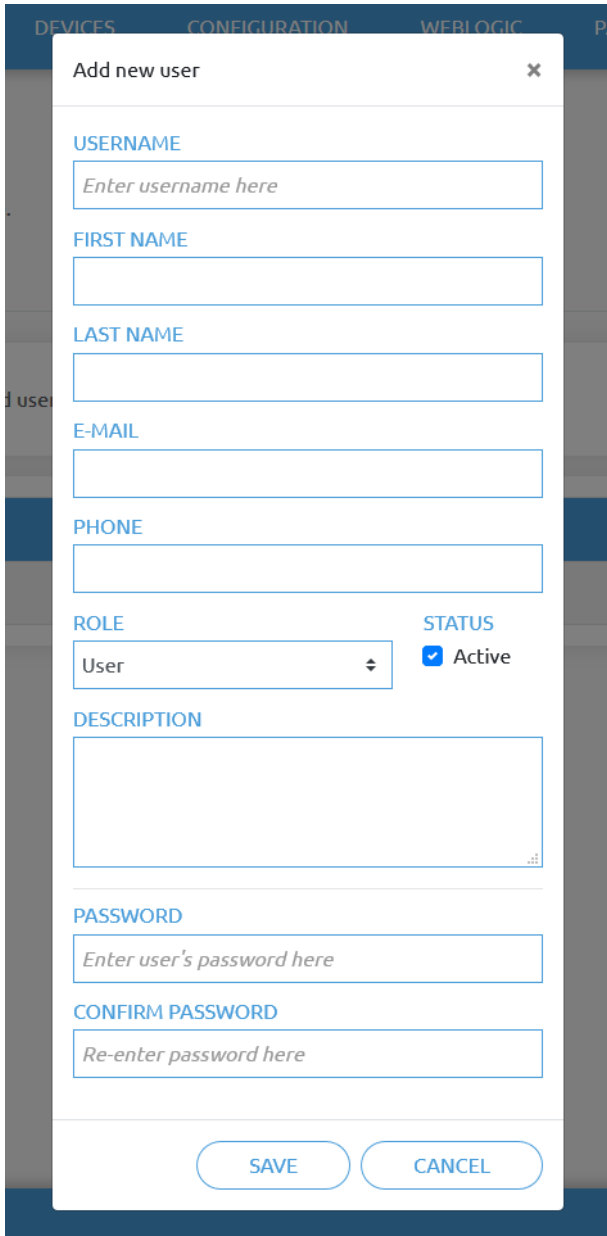

**Add new user** ✕

**USERNAME**

**FIRST NAME**

**LAST NAME**

**E-MAIL**

**PHONE**

**ROLE** **STATUS**  
  Active

**DESCRIPTION**

**PASSWORD**

**CONFIRM PASSWORD**

There are three user levels:

- Administrator
- Operator
- User

Fill in the user information and click **Save**.



Later on to change any user information just click on the edit  icon.

**Account settings**

This page allows modifying your user profile.

My profile **Users**

[ADD NEW USER](#) You can add user on your network to monitor and control the devices.

USERNAME	ROLE	FIRST NAME	LAST NAME	E-MAIL	PHONE	ACTIVE	
admin	Administrator					<input checked="" type="checkbox"/>	
operator	User					<input checked="" type="checkbox"/>	 

To prevent a user to sign-in either could be:

- deactivated by changing its **Active** status in the edit mode
- or removed by clicking the delete  icon.

## 6. Hardware Specification

### 6.1. Technical Sheets

#### 6.1.1. Quick Changers

##### Quick Changer

Name	Quick Changer I/O support – Robot Side	Quick Changer - Robot Side	Quick Changer - Robot Side 4.5A	Quick Changer - Robot Side
Item #	102326	102037	104277	109498
Version	QC-R – I/O	QC-R v2	QC-R v2-4.5	QC-R v3
Illustration				

##### Dual Quick Changer

Name	Dual Quick Changer	Dual Quick Changer 4.5A	Dual Quick Changer
Item #	101788	104293	109878
Version	Dual QC v2	Dual QC v2-4.5	Dual QC v3
Illustration			

If not specified, the data represent the combination of the different Quick Changer types/sides.

Technical data	Min	Typical	Max	Units
Permissible force *	-	-	600*	[N]
Permissible torque *	-	-	40*	[Nm]
Rated payload *	-	-	20*	[kg]
	-	-	44	[lbs]
Repeatability	-	-	±0.02	[mm]
IP Classification	67			
Operating life (Tool change)	-	5.000	-	[cycles]

Technical data	Min	Typical	Max	Units
Operating temperature	5	-	50	[°C]
	41	-	122	[°F]

\* See static load capacity graph below.

	Quick Changer	Quick Changer for I/O	Dual Quick Changer	Quick Changer - Tool Side	Units
Weight	0.06	0.093	0.41	0.14	[kg]
	0.13	0.21	0.9	0.31	[lb]
Dimensions	See Mechanical dimension section				

**QC-R V3 | DQC V3 and the QC-R V2 | QC-R V2-4.5A | DQC V2 | DQC V2-4.5A**

The following graph shows the load capacity that the QC-R V3 | DQC V3 and the QC-R V2 | QC-R V2-4.5A | DQC V2 | DQC V2-4.5A can handle in a static situation. The values for a situation with an acceleration of 2g are half of the static values.

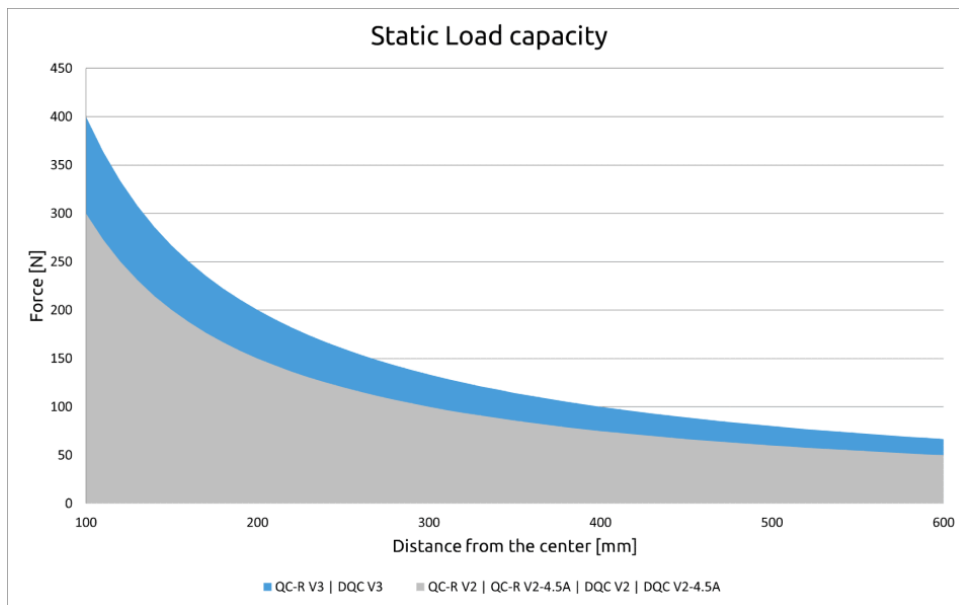

**6.1.2. SG**

General Properties	Minimum	Typical	Maximum	Unit
Total spindle stroke	11	-	40	[mm]
	0.43	-	1.57	[inch]
Spindle position resolution	-	0.1	-	[mm]
	-	0.0039	-	[inch]
Spindle force	-	-	380	[N]
Spindle speed	-	-	37	[mm/s]
	-	-	1.46	[inch/s]

General Properties	Minimum	Typical	Maximum	Unit
Gripping time* (SG-a-H)	-	-	32	[grip/min]
SG-tool attachment mechanism	Smart lock			
Motor	Integrated, electric BLDC			
IP Classification	IP67			
Dimensions (H x Ø)	84 x 98 3.3 x 3.85			[mm] [inch]
Weight	0.77 1.69			[kg] [lb]

\*Gripping time is tool depended. See the separate SG Datasheet for the tool specific gripping time.

Operating Conditions	Minimum	Typical	Maximum	Unit
Power supply	20	24	25	[V]
Current consumption	45	-	600	[mA]
Operating temperature	0 32	- -	50 122	[°C] [°F]
Storage temperature	0 32	- -	60 140	[°C] [°F]
Relative humidity (non-condensing)	0	-	95	[%]

**Warranty:** 3 years or 3,000,000 cycles, whichever comes first, in accordance with the official warranty terms outlined in the Partner Agreement.

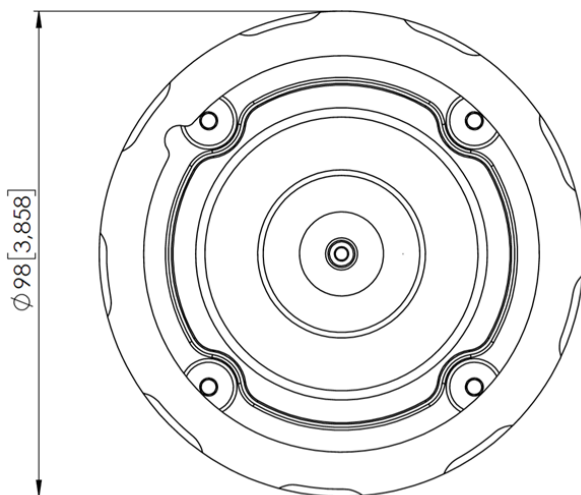

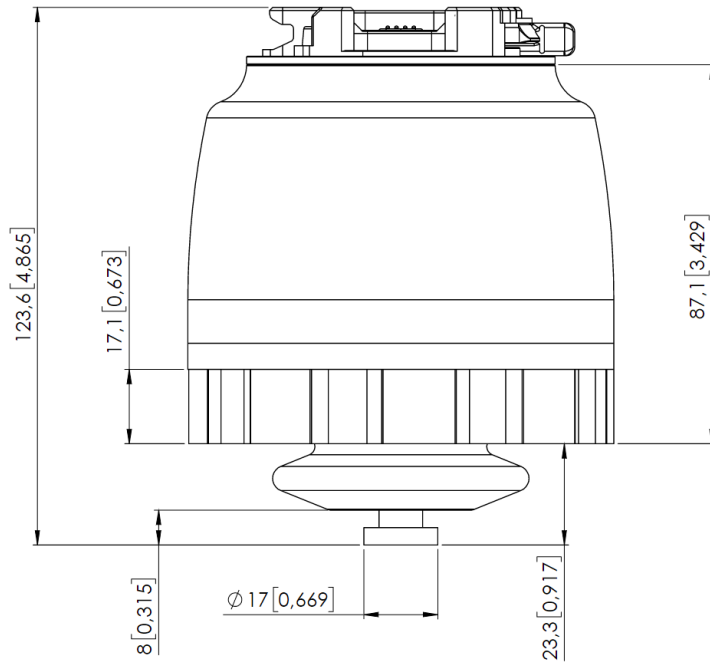

All dimensions are in mm and [inches].

### 6.1.3. Compute Box

#### 6.1.3.1. With 1.5A Wall Adapter (36W)

Supplied Wall Adapter	Minimum	Typical	Maximum	Unit
Input voltage (AC)	100	-	240	[V]
Input current	-	-	1	[A]
Output voltage	-	24	-	[V]
Output current	-	1.5	-	[A]

Compute Box Power input (24V connector)	Minimum	Typical	Maximum	Unit
Supply voltage	-	24	25	[V]
Supply current	-	1.5	-	[A]

Compute Box Power output (Device connector)	Minimum	Typical	Maximum	Unit
Output voltage	-	24	25	[V]
Output current	-	1.5	-	[A]

#### 6.1.3.2. With 6.25A Wall Adapter (150W)

Supplied Wall Adapter	Minimum	Typical	Maximum	Unit
Input voltage (AC)	100	-	240	[V]
Input current	-	-	2.0	[A]

Supplied Wall Adapter	Minimum	Typical	Maximum	Unit
Output voltage	-	24	-	[V]
Output current	-	6.25	-	[A]

Compute Box Power input (24V connector)	Minimum	Typical	Maximum	Unit
Supply voltage	-	24	25	[V]
Supply current	-	6.25	-	[A]

Compute Box Power output (Device connector)	Minimum	Typical	Maximum	Unit
Output voltage	-	24	25	[V]
Output current	-	4.5	4.5*	[A]

\* Peak currents

### 6.1.3.3. Compute Box I/O interface

Power Reference (24V, GND)	Minimum	Typical	Maximum	Unit
Reference output voltage	-	24	25	[V]
Reference output current	-	-	100	[mA]

Output (DO1-DO8)	Minimum	Typical	Maximum	Unit
Output current - altogether	-	-	100	[mA]
Output resistance (active state)	-	24	-	[ $\Omega$ ]

Input (DI1-DI8) as PNP	Minimum	Typical	Maximum	Unit
Voltage level - TRUE	18	24	30	[V]
Voltage level - FALSE	-0.5	0	2.5	[V]
Input current	-	-	6	[mA]
Input resistance	-	5	-	[k $\Omega$ ]

Input (DI1-DI8) as NPN	Minimum	Typical	Maximum	Unit
Voltage level - TRUE	-0.5	0	5	[V]
Voltage level - FALSE	18	24	30	[V]
Input current	-	-	6	[mA]
Input resistance	-	5	-	[k $\Omega$ ]

## 6.2. Mechanical Drawings

### 6.2.1. Mountings

#### 6.2.1.1. Quick Changer - Robot Side

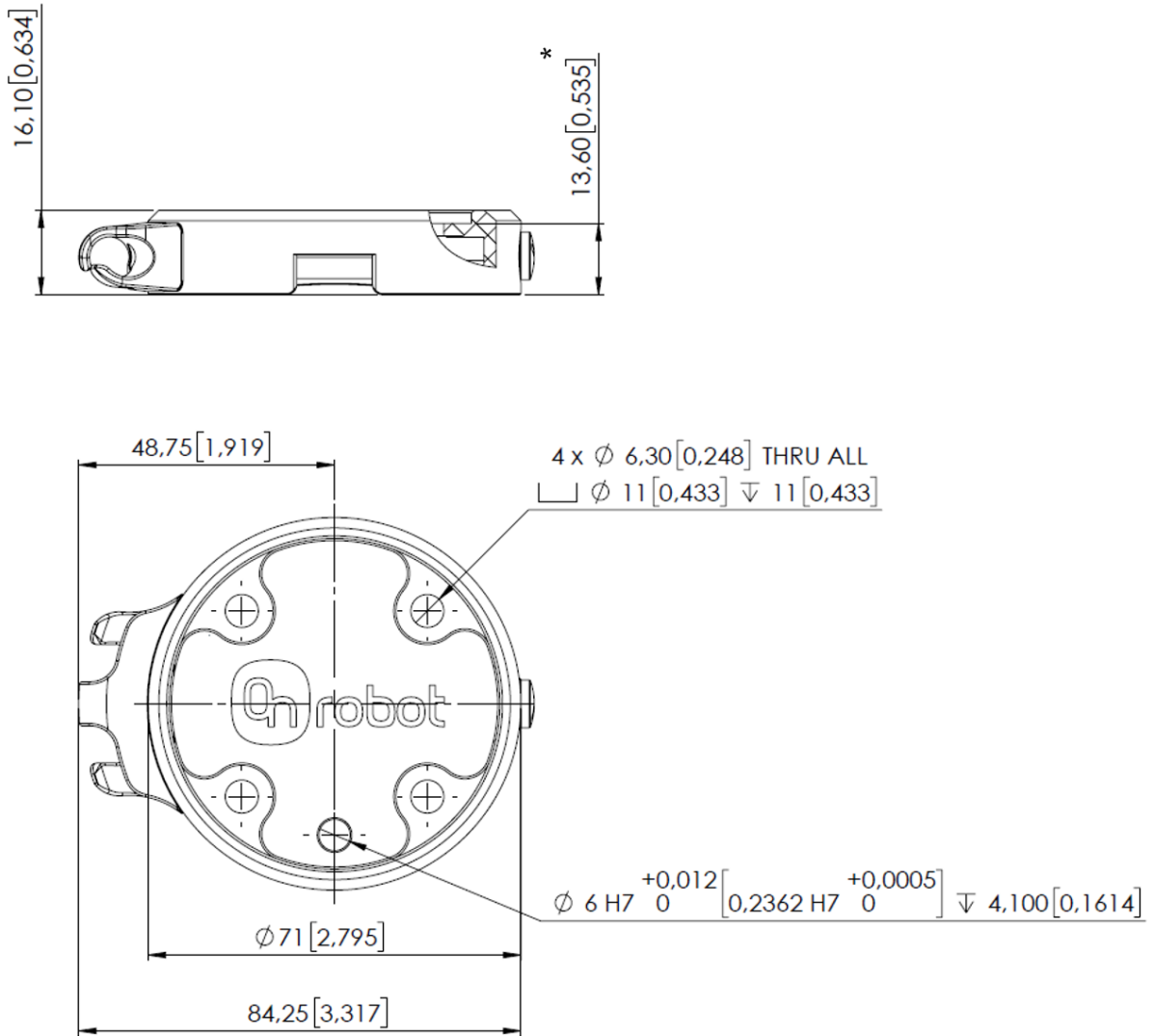

\* Distance from Robot flange interface to OnRobot tool.

All dimensions are in mm and [inches].



**NOTE:**

The cable holder (on the left side) is only required with the long (5 meter) cable.

## 6.2.2. Tools

### 6.2.2.1. SG

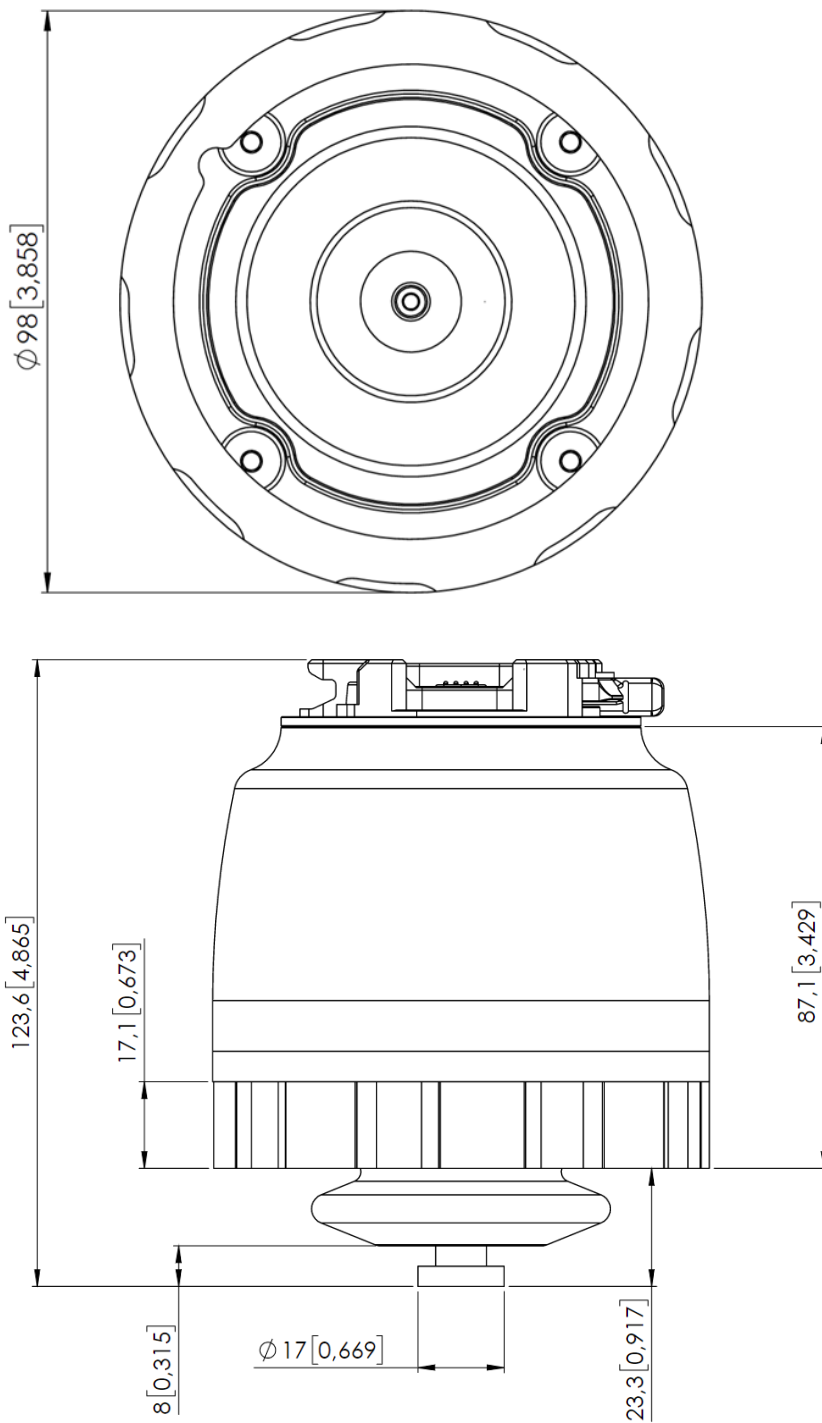

All dimensions are in mm and [inches].

The Silicone Tool parts - that are attached to the SG base part -, are described in the SG Datasheet.

### 6.2.2.2. Compute Box

#### Compute Box

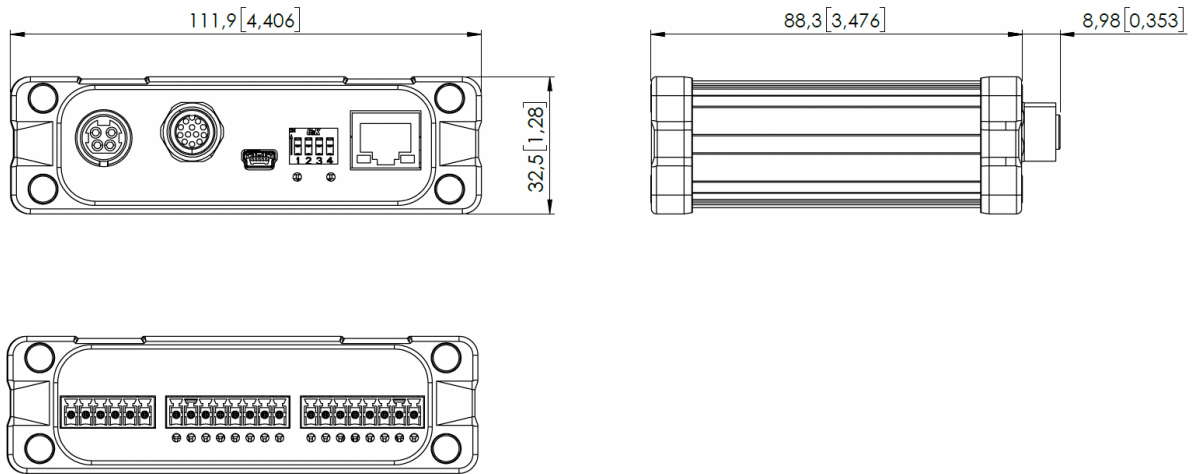

#### Clip-on Bracket (optional)

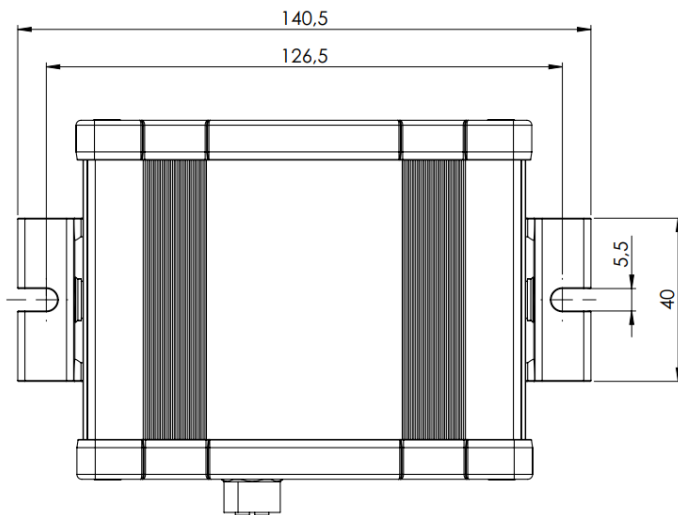

All dimensions are in mm and [inches].

## 6.3. TCP, CoG

Use the TCP/CoG calculator to calculate the TCP and CoG values for your OnRobot product combination.

The TCP/CoG calculator can be downloaded from [www.onrobot.com/downloads](http://www.onrobot.com/downloads).



**NOTE:**

For more information, see the [5.1.5. Web Client: TCP, CoG](#) section.

**TCP, CoG, and weight parameters of the single devices (without any mounting/adapter and/or workpiece):**

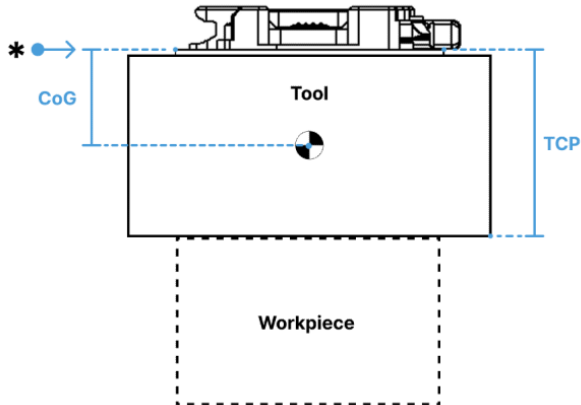

\* The TCP in Z is measured from the tool's base point to the start of the workpiece, as shown in the image. Similarly, the CoG is measured from the same base point to the center of gravity, as indicated.

**6.3.1. SG**

Without any Silicone Tool, only the SG Base Part with spindle in.

Coordinate system	TCP [mm]	Center of Gravity [mm]	Weight
	X=0 Y=0 Z=113	cX=-13 cY=-5 cZ=31	0.77 kg 1.69 lb

With Silicone Tool Type A on (SG-a-S/H).

Coordinate system	TCP [mm]	Center of Gravity [mm]	Weight
	X=0 Y=0 Z=154	cX=-12 cY=-5 cZ=45	0.932 kg 2.05 lb

With Silicone Tool Type B on (SG-b-H).

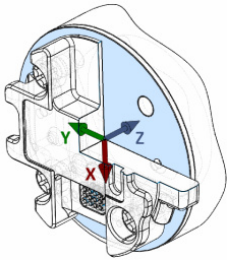
Coordinate system	TCP [mm]	Center of Gravity [mm]	Weight
	<p>X=0 Y=0 Z=155</p>	<p>cX=-12 cY=-5 cZ=46</p>	<p>0.937 kg 2.06 lb</p>

## 7. Maintenance

**WARNING:**

An overall inspection of OnRobot's end-of-arm tooling and accessories must be performed regularly and at least once every 6 months. This inspection must include but is not limited to check for defective material and clean gripping surfaces.

Use original spare parts, and original service instructions for OnRobot's end-of-arm tooling, accessories and the robot. Failure to comply with this precaution can cause unexpected risks, resulting in severe injury.

If you have questions regarding spare parts and repair, please visit our website [www.onrobot.com](http://www.onrobot.com) to contact us.

### 7.1. SG

---

#### For the SG Base Part

**WARNING:**

Please, clean the SG Base Part regularly by using a cloth and a cleaning agent with a pH value between 6-8.

When cleaning the SG Base Part please keep it mounted on the robot to prevent water getting into the connector.

After cleaning, use a cloth and clean water, to rinse of any leftover cleaning agent.

Please ensure that the used cleaning agent does not contain chlorine as this can lead to corrosion.

**WARNING:**

On a regular basis, check that the silicone bellow has not come loose from neither the aluminum base nor the Smart Lock male. If the bellow is not sitting correctly, this can lead to water seeping into the SG base part.

### For the SG Tools

The silicone part and the smart lock female are dishwasher and autoclave safe, at temperatures  $\leq 120^{\circ}\text{C}$  ( $248^{\circ}\text{F}$ ).

Various cleaners can be used for cleaning the silicone part. Dish soap, Alcohol, regular ethanol, isopropanol and acetone works as well for cleaning.

Do not use concentrated acids and alkalis, since these can potentially damage the silicone, in particularly oxidizing acids such as sulfuric or nitric acid. It is recommended to use cleaning agent with a pH value between 2 and 13.



On a regular basis, please do a visual inspection of the smart-lock female and the ball spring. If needed clean it with a brush or cloth.

## 8. Troubleshooting

### 8.1. SG Error Codes

---

#### 8.1.1. Not Initialized

**Error code (on the Web Client and in the robot scripts):** 16

**Description:** The tool has not been initialized.

**Suggestion(s) to solve the error:** Initialize the tool before use. For more information, go to the [5.1.1.1. Web Client: Devices Menu](#) section.

#### 8.1.2. Unknown Silicone

**Error code (on the Web Client and in the robot scripts):** 32

**Description:** The tool does not recognize the silicone type which it has been set up to use. The tool may not have been set up with a valid silicone type from the factory.

**Suggestion(s) to solve the error:**

- Initialize the tool before use. For more information, go to the [5.1.1.1. Web Client: Devices Menu](#) section.
- Set up the tool with a valid silicone type.
- Ensure that there is no defect or damage to the silicone. Replace the silicone if needed.

## 9. Warranties

### 9.1. Patents

Products of OnRobot A/S are protected by several patents; some still in global publication process (Patents pending). All manufacturers of copies and similar products violating any patent claims will be prosecuted.

### 9.2. Product Warranty

Without prejudice to any claim the user (customer) may have in relation to the dealer or retailer, the customer shall be granted a manufacturer's warranty under the conditions set out below. In the case of:

- Following new grippers - namely VG10, VGC10, VGP20, VGP30, RG2, RG6, 2FG7, 2FG14, 2FGP20, 3FG15, 3FG25, SG Base Part, MG10 and Gecko Gripper - exhibiting defects resulting from manufacturing and/or material faults within 3 years or 3.000.000 operating cycles, whichever comes first.
- Non-Gripper products exhibiting defects resulting from manufacturing and/or material faults within 15 months.

from shipment, OnRobot A/S shall provide the necessary spare parts or repair, while the customer (user) shall provide working hours to replace the spare parts in the field.

This warranty does not apply to wearable or consumable parts as listed in the Spare Parts list, including but not limited to fingers, fingertips, bellows, vacuum cups, silicone parts, gecko pads, or other components that are expected to wear down during normal operation. This warranty shall be invalid if the device defect is attributable to improper treatment and/or failure to comply with information contained in the user guides. This warranty shall not apply to or extend to services performed by the authorized dealer or the customer themselves (e.g. installation, configuration, software downloads). The purchase receipt, together with the date of purchase, shall be required as evidence for invoking the warranty. Claims under the warranty must be submitted within two months of the warranty default becoming evident. Ownership of devices or components replaced by and returned to OnRobot A/S shall vest in OnRobot A/S. Any other claims resulting out of or in connection with the device shall be excluded from this warranty. Nothing in this warranty shall attempt to limit or exclude a customer's statutory rights nor the manufacturer's liability for death or personal injury resulting from its negligence. The duration of the warranty shall not be extended by services rendered under the terms of the warranty. Insofar as no warranty default exists, OnRobot A/S reserves the right to charge the customer for replacement or repair. The above provisions do not imply a change in the burden of proof to the detriment of the customer. In case of a device exhibiting defects, OnRobot A/S shall not be liable for any indirect, incidental, special or consequential damages, including but not limited to, lost profits, loss of use, loss of production or damage to other production equipment.

In case of a device exhibiting defects, OnRobot A/S shall not cover any consequential damage or loss, such as loss of production or damage to other production equipment.

### 9.3. Disclaimer

OnRobot A/S continues to improve reliability and performance of its products, and therefore reserves the right to upgrade the product without prior warning. OnRobot A/S ensures that

the content of this manual is precise and correct but takes no responsibility for any errors or missing information.

# 10. Certifications



# CERTIFICATE OF REGISTRATION

This is to certify that the management system of:

## OnRobot A/S

Main Site: Teglværksvej 47 H, 5220 Odense SØ, Denmark  
 Chamber of Commerce: 36492449

See appendix for additional sites and additional site scopes

has been registered by Intertek as conforming to the requirements of:

## ISO 9001:2015

The management system is applicable to:

Development, manufacturing and sale of end-of-arm tooling, software, and complete application solutions for collaborative robotic applications.

**Certificate Number:**

0096721

**Initial Certification Date:**

26 November 2019

**Date of Certification Decision:**

10 November 2025

**Issuing Date:**

11 November 2025

**Valid Until:**

25 November 2028



*Angelique Björklund*

**Angelique Björklund**

MD, Business Assurance Nordics

Intertek Certification AB,  
 P.O. Box 1103,  
 SE-164 22 Kista, Sweden



In the issuance of this certificate, Intertek assumes no liability to any party other than to the Client, and then only in accordance with the agreed upon Certification Agreement. This certificate's validity is subject to the organization maintaining their system in accordance with Intertek's requirements for systems certification. Validity may be confirmed via email at [certificate.validation@Intertek.com](mailto:certificate.validation@Intertek.com) or by scanning the code to the right with a smartphone. The certificate remains the property of Intertek, to whom it must be returned upon request.



## 10.1. Manufacturer Test Certificate

---



All OnRobot products are tested according to OnRobot test specification for the individual product that follows the ISO 9001 standard procedure. OnRobot testing procedure undergoes continuous review and improvement.

## 10.2. EMC



# Attestation of Conformity no. 122-28268-A2

FORCE Technology has performed compliance testing on electrical products since 1967. FORCE Technology is an accredited test house according to EN17025 and participates in international standardization with organizations such as CEN/CENELEC, IEC/CISPR and ETSI. This attestation of conformity with the below mentioned standards and/or normative documents is based on accredited tests and/or technical assessments carried out at FORCE Technology.

<b>Attestation holder</b> OnRobot A/S, Teglværksvej 47H, 5220 Odense SØ, Denmark																	
<b>Product identification - Name (Part no.)</b> <b>Power Supplies:</b> PSU (104788), VER36U240-JA, VES120PS24, VES150PS24 (106034). <b>Controllers:</b> OR:BASE (113073), OR:COM (113088), OR:MACHINE (113090), UR Kit with Compute Box (102344), Doosan Robot kit (102345), Techman/OMRON TM Robot Kit (102359), KUKA-A Robot kit (102360), KUKA-B Robot kit (102361), FANUC Robot kit (102362), Kawasaki-B Robot kit (102363), Kawasaki-C Robot kit (102364), Kawasaki-D Robot kit (102365), Kawasaki-E Robot kit (102366), Yaskawa-F Robot kit (102367), Yaskawa-G Robot kit (102368), Yaskawa-H Robot kit (102369), NACHI-I Robot kit (102370), NACHI-J Robot kit (102371), Hanwha Robot Kit (103208), Eye Box (103707). <b>Mountings:</b> Dual Quick Changer (101788), Dual Quick Changer 4,5A (104293), Dual Quick Changer v2 4,5A (109878), HEX-E QC (102111), HEX-H QC (102376), Quick Changer I/O (102326), Quick Changer Kit (102277), Quick Changer Kit 4,5A (104388), Quick Changer Robot side (102037), Quick Changer Robot side 4,5A (104277). <b>Tools:</b> 2FG7 (106376), 3FG15 (103666), 2FGP20 (108585), Eyes Lighting Kit (107080), Gecko Gripper (104086/104087/104088), Lift100 (108800), Lift100V2 (109000), MG10 (105202), Eyes (103903), Pallet Station (109401), RG2 (102012), RG2-FT (102075), RG6 (102021), Sander (104876), Screwdriver (103961), SG (103546), VG10 (101661), VGC10 (102844), VGP20 (107242).																	
<b>Manufacturer</b> OnRobot A/S																	
<b>Technical documentation</b> FORCE Technology Assessment no. 122-28268-A1 and 122-28268-A2.																	
<b>Standards/Normative documents</b> <table border="0"> <tr> <td>IEC 61000-3-2:2018</td> <td>EN 61000-3-3:2013</td> </tr> <tr> <td>IEC 61000-3-3:2013</td> <td>EN 61000-3-3:2013/A1:2019</td> </tr> <tr> <td>IEC 61000-3-3:2013/AMD1:2017</td> <td>EN 61000-6-2:2005</td> </tr> <tr> <td>IEC 61000-6-2:2016</td> <td>EN 61000-6-2:2005/AC:2005</td> </tr> <tr> <td>IEC 61000-6-4:2018</td> <td>EN IEC 61000-6-2:2019</td> </tr> <tr> <td>EMC Directive 2014/30/EU, Article 6</td> <td>EN 61000-6-4:2007</td> </tr> <tr> <td>EN 61000-3-2:2014</td> <td>EN 61000-6-4:2007/A1:2011</td> </tr> <tr> <td>EN IEC 61000-3-2:2019</td> <td>EN IEC 61000-6-4:2019</td> </tr> </table> <p>Additionally, for RG2 (102012), RG6 (102021), Lift100 (108800) and Lift100V2 (109000):                  IEC 61326-3-1:2017, Industry locations, SIL 2      EN 61326-3-1:2017, Industry locations, SIL 2</p> <p>The product identified above has been assessed and complies with the specified standards/normative documents. The attestation does not include any market surveillance. It is the responsibility of the manufacturer that mass-produced apparatus have the same properties and quality. This attestation does not contain any statements pertaining to the requirements pursuant to other standards, directives or laws other than the above mentioned.</p>		IEC 61000-3-2:2018	EN 61000-3-3:2013	IEC 61000-3-3:2013	EN 61000-3-3:2013/A1:2019	IEC 61000-3-3:2013/AMD1:2017	EN 61000-6-2:2005	IEC 61000-6-2:2016	EN 61000-6-2:2005/AC:2005	IEC 61000-6-4:2018	EN IEC 61000-6-2:2019	EMC Directive 2014/30/EU, Article 6	EN 61000-6-4:2007	EN 61000-3-2:2014	EN 61000-6-4:2007/A1:2011	EN IEC 61000-3-2:2019	EN IEC 61000-6-4:2019
IEC 61000-3-2:2018	EN 61000-3-3:2013																
IEC 61000-3-3:2013	EN 61000-3-3:2013/A1:2019																
IEC 61000-3-3:2013/AMD1:2017	EN 61000-6-2:2005																
IEC 61000-6-2:2016	EN 61000-6-2:2005/AC:2005																
IEC 61000-6-4:2018	EN IEC 61000-6-2:2019																
EMC Directive 2014/30/EU, Article 6	EN 61000-6-4:2007																
EN 61000-3-2:2014	EN 61000-6-4:2007/A1:2011																
EN IEC 61000-3-2:2019	EN IEC 61000-6-4:2019																
<b>Signature</b>  <b>Knud A. Baltzen</b>	Digitally signed by Knud A. Baltzen Date: 2023.11.17 09:43:00 +01'00'																
Signed by: Knud A. Baltzen, Senior Specialist, Product Compliance																	



FORCE Technology  
 Venlighedsvej 4  
 2970 Hørsholm, Denmark  
 +45 43 25 14 00  
 +45 43 25 00 10  
 info@forcetechnology.dk

FORCE Technology Norway AS  
 Nye Vakkås vei 32  
 1395 Hvalstad, Norway  
 +47 64 00 35 00  
 +47 64 00 35 01  
 info@forcetechnology.no

FORCE Technology  
 Park Allé 345  
 2605 Brøndby, Denmark  
 +45 43 25 00 00  
 +45 43 25 00 10  
 info@forcetechnology.dk

### 10.3. SG - Environment



## Attestation of Conformity no. 119-35752

<p><b>Assessment holder</b></p> <p>OnRobot A/S                  Teglværksvej 47H                  5220 Odense SØ                  Denmark</p>					
<p><b>Product identification</b></p> <p>OnRobot SG Base Unit</p>					
<p><b>FORCE Technology test reports</b></p> <p>Environmental tests of SG Base Unit, report no.: 119-35752-1 dated 06 January 2020</p>					
<p><b>Other technical documentation</b></p>					
<p><b>Conclusion</b></p> <p>The SG Base Unit have been tested according to the standards listed below. The test results are given in the Force report listed above. All tests were carried out as specified in the relevant specifications including special test criteria's stated by the client.</p> <table data-bbox="207 1299 829 1388"> <tr> <td>IP 6X</td> <td>IEC 60529:2013</td> </tr> <tr> <td>IP X7</td> <td>IEC 60529:2013</td> </tr> </table>		IP 6X	IEC 60529:2013	IP X7	IEC 60529:2013
IP 6X	IEC 60529:2013				
IP X7	IEC 60529:2013				
<p><b>Date</b></p>	<p>2020.01.06</p>				
<p><b>Signature</b></p>					



**FORCE Technology**  
 Nordborgvej 81, L7-514  
 6430 Nordborg  
 Tel. +45 43 25 14 00  
 Fax +45 43 25 00 10

FORCE Technology Norway AS  
 Nye Vaksø vei 32  
 1395 Hvalstad, Norway  
 +47 64 00 35 00  
 +47 64 00 35 01  
 info@forcetechnology.no

FORCE Technology Sweden AB  
 Tallmätargatan 7  
 72134 Västerås, Sweden  
 +46 (0)21-490 3000  
 +46 (0)21-490 3001  
 info@forcetechnology.se

FORCE Technology  
 Park Allé 345  
 2605 Brøndby, Denmark  
 +45 43 25 00 00  
 +45 43 25 00 10  
 info@forcetechnology.dk  
 www.forcetechnology.com

## 10.4. SG-x-H

---

### DECLARATION OF CONFORMITY

According to Regulation (EC/EU) No.1935/2004 Article 3, it is required that food contact articles “*must be sufficient inert to preclude substances from being transferred to food in quantities large enough to endanger human health or to bring about an unacceptable change in the composition of the food or a deterioration in its organoleptic properties*”.

This document stands to certify that all OnRobot SG-x-H materials, intended for food contact complies with:

#### 1. Europe:

Regulation (EC/EU) No. 1935/2004 and national provisions (Article 6). The materials of SG Tools are suitable for food contact, materials and articles under article 3 of the before mentioned regulation. Compliance with the, requirements of Regulation (EC/EU) No.1935/2004 for the food contact material or article, concerning any limitations in particular max. use limits or limits on migration or extraction, the effect on taste and smell of the food and the suitability of the article for the specific use must be in compliance with the recommendations of the BfR.

*See results next page.*

#### 2. USA:

FDA 21 CFR 177.2600 “*Rubber articles intended for repeated use in contact with food*”.

*Tested and approved for use on non-fatty food objects.*

*See results next page.*

The above product is also produced according to EC regulation 2023/2006 “*Good manufacturing practice for materials and articles intended to come into contact with food*” and is subject to control by the Danish food and health authorities.

To the best knowledge of the manufacturer, that the information presented in this certificate, is correct as of date of the declaration. It is the responsibility of the end-user to ensure that the status of the regulation is still in effect at the date of use.

Odense, April 6th, 2020

Group Management



Vilmos Beskid

CTO

### Results

The materials and color additive have been tested for extraction and migration limits by an independent testing organization (Eurofins Product Testing A/S. Accreditation number 522)

Sensory Analysis:

Parameter:	Food Simulant:	Median Grade:	Limit Value*
Odour	Water	1.5 (Just recognizable to slight deviation, chemical)	2.5
Taste	Water	2.5 (Slight to intense deviation, chemical and flavoured)	2.5

\* From 61. Statement of BfR, Bundesgesundheitsbl. 46, 2003, 362-5.

Analysis - BfR recommendation XV on silicone:

Parameter:	Result:	Limit value **
Extractable components in water	< 0.2 %	0.5 %
Extractable components in 3% acetic acid	< 0.3 %	0.5 %
Extractable components in 10% ethanol	< 0.2 %	0.5 %
Volatile Compounds	< 0.1 %	0.5 %
Platinum	5 mg/kg	50 mg/kg

\*\* According to BfR recommendation XV on silicone

Extraction Analysis:

Parameter:	Single determinations [mg/ inch <sup>2</sup> ]	Limit Value [mg/ inch <sup>2</sup> ]
Water-extracted residue after 7 hours	0.19	< 20
Water-extracted residue after +2 hours	< 0.1	< 1

## 10.5. SG-x-S

---

### DECLARATION OF CONFORMITY

According to Regulation (EC/EU) No.1935/2004 Article 3, it is required that food contact articles *“must be sufficient inert to preclude substances from being transferred to food in quantities large enough to endanger human health or to bring about an unacceptable change in the composition of the food or a deterioration in its organoleptic properties”*.

This document stands to certify that all OnRobot SG-x-S materials, intended for food contact complies with:

#### 1. Europe:

Regulation (EC/EU) No. 1935/2004 and national provisions (Article 6). The materials of SG Tools are suitable for food contact, materials and articles under article 3 of the before mentioned regulation. Compliance with the, requirements of Regulation (EC/EU) No.1935/2004 for the food contact material or article, concerning any limitations in particular max. use limits or limits on migration or extraction, the effect on taste and smell of the food and the suitability of the article for the specific use must be in compliance with the recommendations of the BfR.

*See results next page.*

#### 2. USA:

FDA 21 CFR 177.2600 *“Rubber articles intended for repeated use in contact with food”*.

*Tested and approved for use on non-fatty food objects.*

*See results next page.*

The above product is also produced according to EC regulation 2023/2006 *“Good manufacturing practice for materials and articles intended to come into contact with food”* and is subject to control by the Danish food and health authorities.

To the best knowledge of the manufacturer, that the information presented in this certificate, is correct as of date of the declaration. It is the responsibility of the end-user to ensure that the status of the regulation is still in effect at the date of use.

Odense, April 6th, 2020

Group Management



Vilmos Beskid

CTO

### Results

The materials and color additive have been tested for extraction and migration limits by an independent testing organization (Eurofins Product Testing A/S. Accreditation number 522)

**For the Hard Part**

Sensory Analysis:

Parameter:	Food Simulant:	Median Grade:	Limit Value*
Odour	Water	1.5 (Just recognizable to slight deviation, chemical)	2.5
Taste	Water	2.5 (Slight to intense deviation, chemical and flavoured)	2.5

\* From 61. Statement of BfR, Bundesgesundheitsbl. 46, 2003, 362-5.

Analysis - BfR recommendation XV on silicone:

Parameter:	Result:	Limit value **
Extractable components in water	< 0.2 %	0.5 %
Extractable components in 3% acetic acid	< 0.3 %	0.5 %
Extractable components in 10% ethanol	< 0.2 %	0.5 %
Volatile Compounds	< 0.1 %	0.5 %
Platinum	5 mg/kg	50 mg/kg

\*\* According to BfR recommendation XV on silicone

Extraction Analysis:

Parameter:	Single determinations [mg/ inch <sup>2</sup> ]	Limit Value [mg/ inch <sup>2</sup> ]
Water-extracted residue after 7 hours	0.19	< 20
Water-extracted residue after +2 hours	< 0.1	< 1

**For the Soft Part**

Parameter:	Food Simulant:	Median Grade:	Limit Value*
Odour	Water	1 (Just recognizable to slight deviation, chemical)	2.5
Taste	Water	1 (Slight to intense deviation, chemical and flavoured)	2.5

\* From 61. Statement of BfR, Bundesgesundheitsbl. 46, 2003, 362-5.

Analysis - BfR recommendation XV on silicone:

Parameter:	Result:	Limit value **
Extractable components in water	< 0.2 %	0.5 %
Extractable components in 3% acetic acid	< 0.3 %	0.5 %
Extractable components in 10% ethanol	< 0.2 %	0.5 %
Volatile Compounds	< 0.1 %	0.5 %
Platinum	10 mg/kg	50 mg/kg

\*\* According to BfR recommendation XV on silicone

Extraction Analysis:

Parameter:	Single determinations [mg/ inch <sup>2</sup> ]	Limit Value [mg/ inch <sup>2</sup> ]
Water-extracted residue after 7 hours	1.5	< 20
Water-extracted residue after +2 hours	< 0.1	< 1

## 10.6. Declaration of Incorporation

---

### 10.6.1. SG

#### CE/EU Declaration of Incorporation (Original)

According to European Machinery Directive 2006/42/EC annex II 1.B.

The manufacturer:

OnRobot A/S  
 Teglværskvej 47H  
 DK-5220, Odense SØ  
 DENMARK

declares that the product:

Type:	Industrial Robot Gripper
Model:	SG
Generation:	V1
Serial:	1000000000-1009999999

may not be put into service before the machinery in which it will be incorporated is declared in conformity with the provisions of Directive 2006/42/EC, including amendments, and with the regulations transposing it into national law.

The product is prepared for compliance with all essential requirements of Directive 2006/42/EC under the correct incorporation conditions, see instructions and guidance in this manual. The following essential requirements of Directive 2006/42/EC are fulfilled: 1.1.2, 1.1.3, 1.1.5, 1.3.2, 1.3.4, 1.5.1, 1.5.2, 1.5.4, 1.5.5, 1.5.10, 1.5.11, 1.5.12, 1.6.1. Compliance with all essential requirements of Directive 2006/42/EC relies on the specific robot installation and the final risk assessment.

Technical documentation is compiled according to Directive 2006/42/EC annex VII part B and available in electronic form to national authorities upon legitimate request. Undersigned is based on the manufacturer address and authorized to compile this documentation.

Additionally, the product declares in conformity with the following directives, according to which the product is CE marked:

2014/30/EU — Electromagnetic Compatibility Directive (EMC)  
 2011/65/EU — Restriction of the use of certain hazardous substances (RoHS)

Relevant essential health and safety requirements of the following EU directives are also applied:

2014/35/EU — Low Voltage Directive (LVD)  
 2012/19/EU — Waste of Electrical and Electronic Equipment (WEEE)

A list of applied harmonized standards, including associated specifications, is provided in this manual.

Budapest, November 11th, 2020

Group Management



Vilmos Beskid  
 CTO